

CK25

CALANDRA RACING CONCEPTS SETUP SHEET

Driver: _____
 Date: _____
 Event: _____
 Track: _____
 Result: _____

Track Conditions

- CRC Black CRC Grey ETS

 Low Medium High
 Small Medium Large
 Smooth Both Bumpy
 Temp: _____ Humidity: _____

Shock

Oil: _____
 Spring: _____
 Length: _____
 Preload: _____

Damper Tube

- 5k 10k 15k 20k

Front Tires

Compound: _____
 Diameter: _____
 Additive: _____
 Soak time: _____

Rear Tires

Compound: _____
 Diameter: _____
 Additive: _____
 Soak time: _____

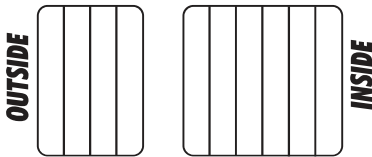

Electronics

Motor: _____
 Timing: _____
 Battery: _____
 ESC: _____
 Ratio: _____

Aerodynamics

Body: _____
 Position: _____
 Car weight: _____

Suspended Pod: _____
 (Shock lenght)

Race Ready Pod: _____
 (Shock Preload)

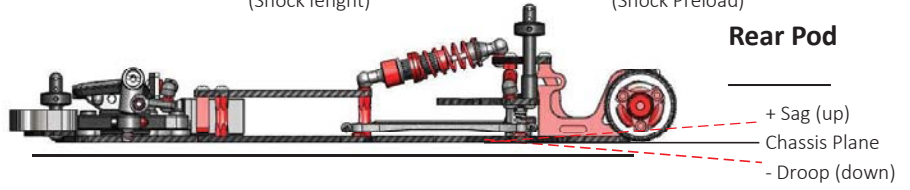

Ride Height - Front: _____ Middle: _____ Rear: _____

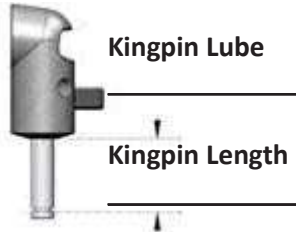

Kingpin Lube _____
 Kingpin Length _____
 Front Spring
 45 50 55 60

Dynamic Caster Block

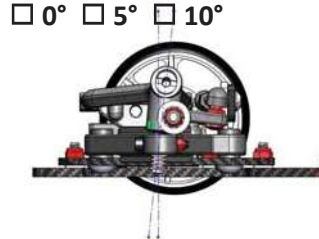

0° 5° 10°
 Caster
 3 shims front
 2 shims front
 1 shim front
 All shims back

Camber: _____



Roll Center Spacer
 0mm
 2mm
 2.5mm

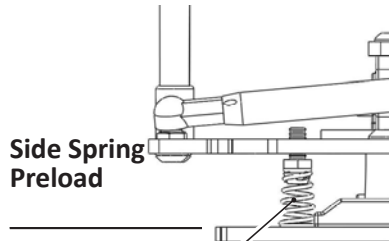

Side Spring Preload
 Side Spring
 45 50 55 60

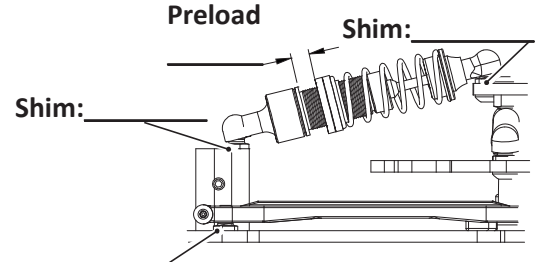

Rear Steer - Shim: _____

Battery Position

- Forward
 Rearward

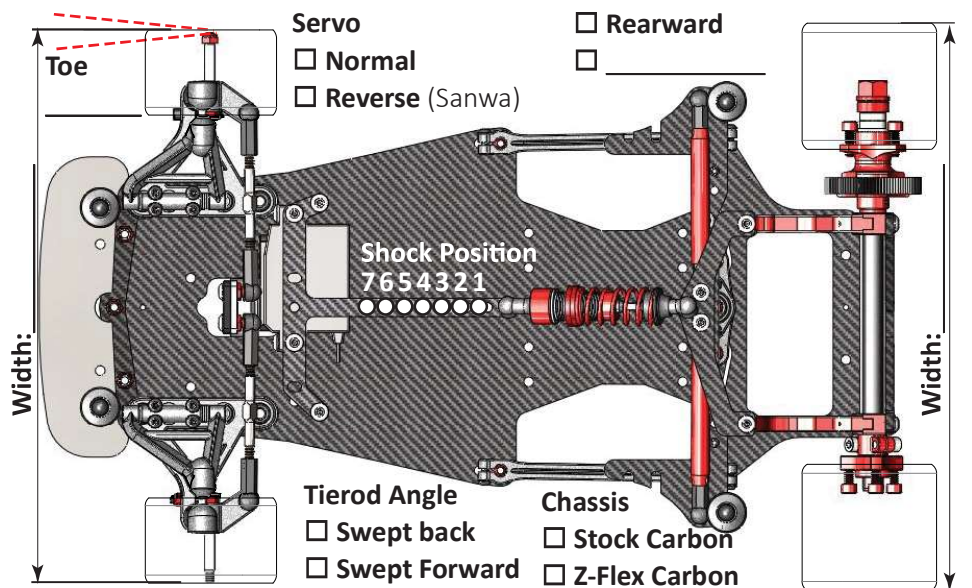

Front Brace: Yes No

Tierod Angle

- Swept back
 Swept Forward
 Straight

Chassis

- Stock Carbon
 Z-Flex Carbon
 Aluminium